

Create your
own storage
solution

COMBO BOX SERIES



O-Life[®]
Enjoy Life - Life in Joy!

Appreciation

During time passing, we have been trying to create an ideal life style. What we want to share with you is the aspiration of better life and the solutions for more comfortable living. And we are proud to tell you that we really achieve it!

For those old friends who have been standing with us for long time, we appreciate for your support and encouragement. You accompanied us and brought us the great strength to do more and to be better. For those new friends who have just opened this book, we appreciate you to give us an opportunity to let us share our pleasant and accomplishment with you.

With opening this book, the wonderful journey you are going to start is to see our great design, idea and passion to life. You will see that "Enjoy Life" is not just an action but a life attitude. "Life in Joy" should not be just a dream but a dream come true. And O-LIFE is not just a brand, it's a sincere friend to all of you.

Certification

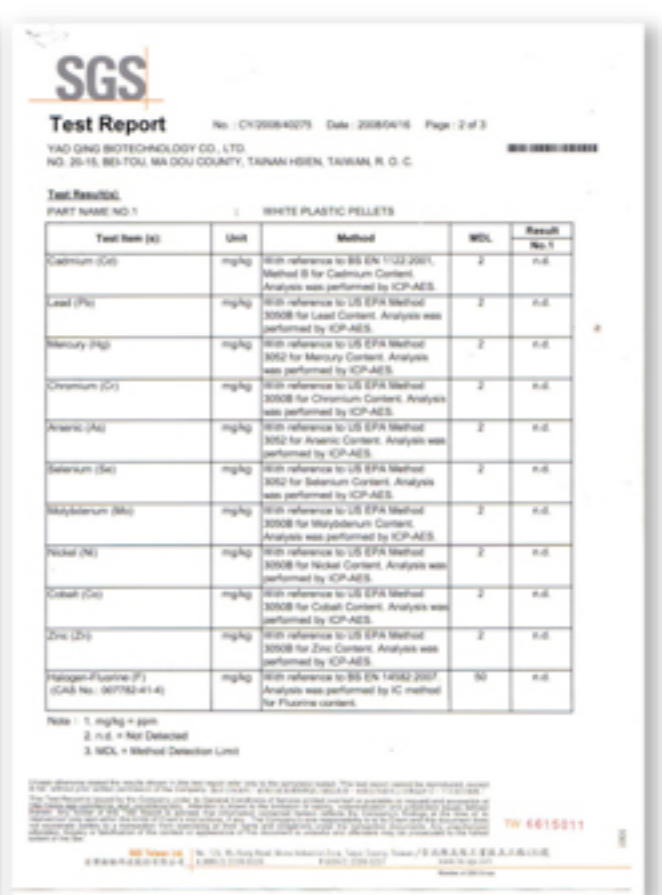
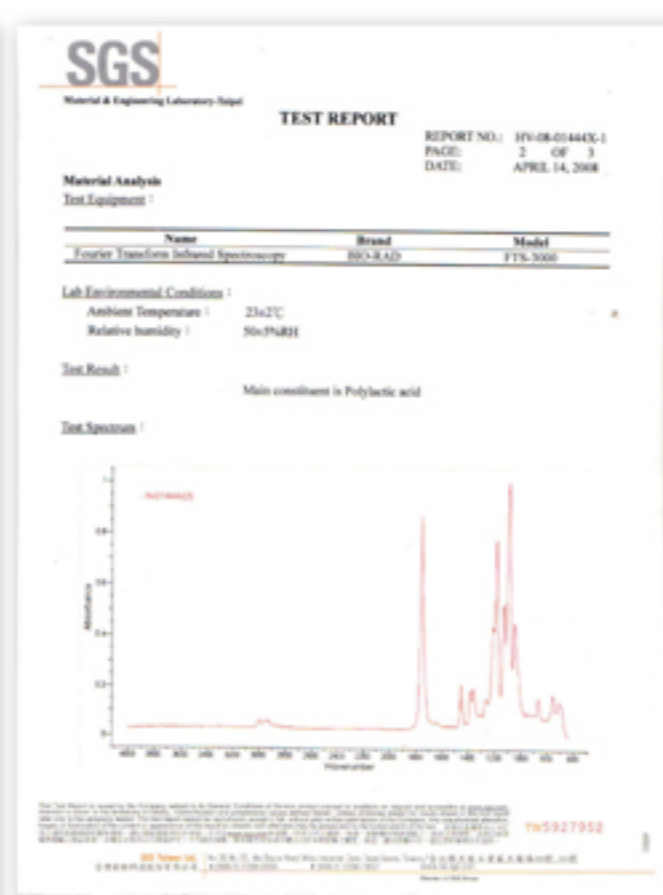

CARE

Do you know you have started to use a small crayon since you were five? Do you know there could be more than 20 kinds of different stationeries helping you when you are in work? Do you know you may spend 8 hours a day, 2,100 hours a year, which is 121,800 hours in your lifetime for sitting in front of your desk? Or even more!

We know it. Because we do care about it! We care if the children have their painting tools that are safe and free from any harmful material. We care that even just a 10-degree difference of the angle from monitor to your eyes can prevent you from an unknown headache after you call the day off and go home. We even care that stationery should not be just a normal work accessory to you. It should bring you comfort, convenience and commitment to a better life style.

The only thing we want to see from you is your smile of satisfaction. We are all ready to present our best products and service. If you are also ready to turn your life to the great & new direction, please just turn the page on. We may surprise you with our amazing items. But you will surprise yourself more by how wonderful life could be when you make this decision!

INDEX

There are some life solutions for you.

Storage Solution

Modular Drawer

Combo Box	02
Join Box	04

Cabinet Storage

Folding Box	06
Smart Caddy	08

Drawer Storage

Smart Blocks	12
--------------	----

Wall Storage

Bubble Series	16
Pocket Series	18

Vanity Storage

Makeup Organizer	20
Vanity Use Case	22

Living Room Storage

Remote Control Holder	24
Living Room Use Case	24
Entrance Use Case	26

Working Solution

Smart Organizer

Target Series	28
Smart Series	32

Desk Organizer

Twotone Series	34
S Series	38

Office Accessories

Memo Holder	42
Desk Accessories	44
Magazine File	45
Desk Pad	45



Modular Drawer

Create your own storage system

- Combo Box -
- Join Box -

Combo Box

we modularized the drawer storage box by design. You can combine and match according to your own needs. Whether it is a long drawer or a small drawer, you can move it at will, or even remove it completely to use as an open storage layer.



Compared with other drawers, Combo box adds customized functions.



Working Storage



Cabinet Storage



Cosmetic Storage



Stackable

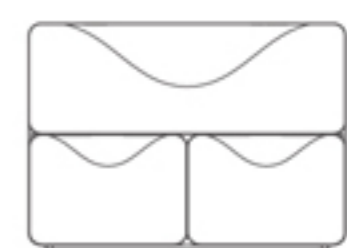

Sort by demand



Video

Advantage

Modularity :

Allow users to have as many drawers as they want.

Versatility :

Applicable to multiple fields, users can expand it as their needs increase.

Decorative :

Storage at home is not only about function and capacity, decoration is also important.



Stacking fixed design to prevent falling.



Entrance



Customized Colors



ITEM NO.	S-3382
PACKING	1 SET/SHRINK, 18 SETS/CTN/0.064CBM 8.5/10KGS
SIZE	200 x 95 x 143 (mm)
COLOR	01 18 24 25 31 00



ITEM NO.	S-3383
PACKING	1 SET/SHRINK, 18 SETS/CTN/0.064CBM 8.7/10.2KGS
SIZE	200 x 95 x 143 (mm)
COLOR	01 18 24 25 31 00



ITEM NO.	S-3384
PACKING	1 SET/SHRINK, 18 SETS/CTN/0.064CBM 8.9/10.4KGS
SIZE	200 x 95 x 143 (mm)
COLOR	01 18 24 25 31 00

Join Box

we found that the drawer on the market is mainly based on wardrobes, with a depth of more than 40cm.

In addition to wardrobes, there are many shallow cabinets at home, such as bookcases, wall shelves, etc., with a depth of only 25 to 30cm.

Therefore, we control the length of the drawers to 20 cm, making them suitable for use on desks, bookcases and wall shelves.



The advantage of modularity is that users can expand it according to their needs.



Stackable and Fixed



Suitable Length (25cm)



Cleanable



Use Case

Bookcase :

You can use the Join Box series to organize the space in the bookcases and keep them organized.

Desktop :

On the desk, in addition to storing electronic accessories, the Join box can even be used as a headphone stand.



Cosmetic :

The Join Box can be expanded to store cosmetics and skin care products as supplies increase.



ITEM NO.	S-710
PACKING	1 SET/SHRINK, 18 SETS/CTN/0.038CBM 4.4/5.4KGS
SIZE	225 x 90 x 85 (mm)
COLOR	01 18 24 25 00



ITEM NO.	S-720
PACKING	1 SET/SHRINK, 24 SETS/CTN/0.093CBM 9.7/10.7KGS
SIZE	225 x 90 x 167 (mm)
COLOR	01 18 24 25 00

Cabinet Storage

Not only useful, but also decorative

- Folding Box -
- Smart Caddy -

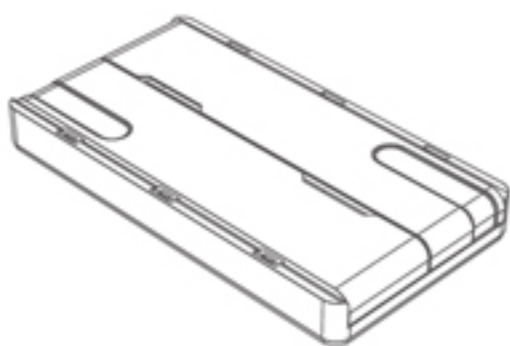

Easy to store in the folded state,
waiting for the opportunity to use



Vertical storage is
suitable for deeper cabinets



Horizontal storage is
suitable for shallow cabinets

Folding Box

According to our observations,
More and more consumers
pay attention to decoration.
Because it is seen every day,
an elegant interior must be
matched with elegant
storage supplies.



Step 1.



Step 2.



ITEM NO.	S-310
PACKING	1 SET/SHRINK, 36SETS/CTN/0.071/CBM 11/12 KGS
SIZE	303 x 163 x 104.2 (mm)
COLOR	T01 01 18 31 00



ITEM NO.	S-31011
PACKING	1 SET/SHRINK, 24SETS/CTN/0.107/CBM 14/15 KGS
SIZE	330 x 203 x 144 (mm)
COLOR	T01 01 18 31 00



ITEM NO.	S-3102
PACKING	2 SETS/SHRINK, 24SETS/CTN/0.092CBM 12/13KGS
SIZE	303 x 163 x 68 (mm)
COLOR	T01 01 18 31 00

Use Case

Closet :

Clothing accessories are the most diverse and need to be stored in categories, such as socks, underwear, ties, belts, etc.



Closet

Cabinet :

At home, cabinets are often stored with a variety of items, such as medical supplies, pet supplies, shoe supplies...etc. They all needed to be sorted.



Cabinet



Video

Smart Caddy

Smart Caddy is a storage product suitable for moving, whether it is moved from the cabinet to the desktop, or from place A to place B.

Smart Caddy has two handles : active and fixed handle, and three sizes suitable for various purposes.



Video



Stackable

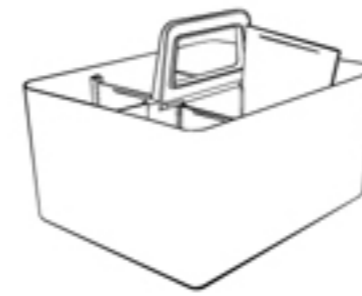

Adjustable dividers

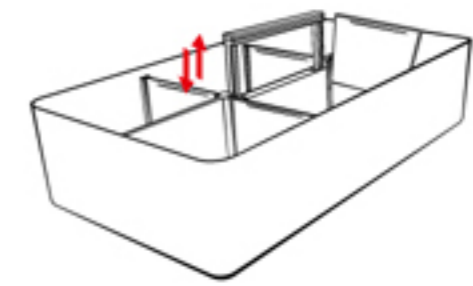

Active handle



ITEM NO.	S-282
PACKING	1 SET/PAPER BAND, 18 SETS/CTN/0.075CBM 6/7.5KGS
SIZE	204 x 164 x 143 (mm)
COLOR	01 04 18 31 00 (Fixed handle)



ITEM NO.	S-280
PACKING	1 SET/SHRINK, 18 SETS/CTN/0.077CBM 6.2/7.2KGS
SIZE	204 x 164 x 101 (mm)
COLOR	01 04 18 31 00 (Active handle)



Cosmetic



Skin Care



Stationery



ITEM NO. S-322
 PACKING 1 SET/PAPER BAND, 18 SETS/CTN/0.075CBM 6/7.5KGS
 SIZE 304 x 164 x 113 (mm)
 COLOR 01 04 18 31 00 (Fixed handle)



ITEM NO. S-320
 PACKING 1 SET/SHRINK, 18 SETS/CTN/0.077CBM 6/7KGS
 SIZE 304 x 164 x 71 (mm)
 COLOR 01 04 18 31 00 (Active handle)



Cosmetic



Desk Organizer



Tool Box



ITEM NO. S-452
 PACKING 1 SET/PAPER BAND, 12 SETS/CTN/0.075CBM 5.1/6.1KGS
 SIZE 250 x 180 x 148 (mm)
 COLOR 01 18 31 00 (Fixed handle)



Bath Products



Cleaning Supplies



ITEM NO.	S-28011
PACKING	1 SET/SHRINK, 12 SETS/CTN/0.069CBM 7.1/8.1KGS
SIZE	204 x 164 x 149 (mm)
COLOR	01 04 18 31 00

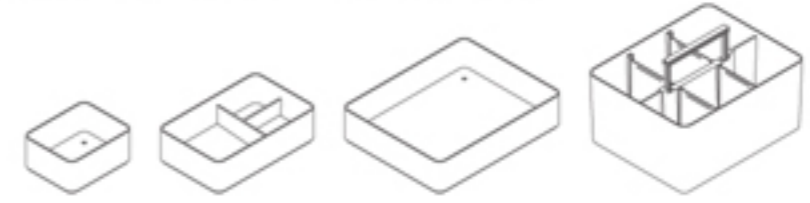

ITEM NO.	S-32011
PACKING	1 SET/SHRINK, 12 SETS/CTN/0.084CBM 7.1/8.4KGS
SIZE	304 x 164 x 114 (mm)
COLOR	01 04 18 31 00



Fixed Handle

ITEM NO.	S-2822
PACKING	2 PCS/SET/PAPER BAND, 12 SETS/CTN/0.097CBM 8/9.5KGS
SIZE	204 x 164 x 236 (mm)
COLOR	01 04 18 31 00



Fixed Handle

ITEM NO.	S-3222
PACKING	2 PCS/SET/PAPER BAND, 12 SETS/CTN/0.098CBM 8/9.5KGS
SIZE	304 x 164 x 175 (mm)
COLOR	01 04 18 31 00



Fixed Handle

ITEM NO.	S-4522
PACKING	2 PCS/SET/PAPER BAND, 6 SETS/CTN/0.068CBM 5/6 KGS
SIZE	250 x 180 x 245 (mm)
COLOR	01 18 31 00



Fixed Handle

ITEM NO.	S-2823
PACKING	3 PCS/SET/PAPER BAND, 6 SETS/CTN/0.117CBM 6/7.5KGS
SIZE	204 x 164 x 287 (mm)

Active Handle

ITEM NO.	S-2803
PACKING	3 PCS/SET/SHRINK, 6 SETS/CTN/0.07CBM 5.8/6.8KGS
SIZE	204 x 164 x 287 (mm)



Fixed Handle

ITEM NO.	S-3223
PACKING	3 PCS/SET/PAPER BAND, 6 SETS/CTN/0.082CBM 6/7.5KGS
SIZE	304 x 164 x 240 (mm)

Active Handle

ITEM NO.	S-3203
PACKING	3 PCS/SET/SHRINK, 6 SETS/CTN/0.07CBM 5.8/6.8KGS
SIZE	304 x 164 x 198 (mm)



Drawer Storage

Classification is more important than size

- Blocks Series -



Blocks Series

The Blocks Series comes in 7 sizes, each of which can be stacked and matched with each other, making it very suitable for organizing and storing a large number of diverse items.



Cabinet



Drawer



Desktop



Video



ITEM NO. S-0810
 PACKING 1 SET/SHRINK, 144 SETS/CTN/0.062CBM 7.2/8.2KGS
 SIZE 80 x 100 x 45 (mm)
 COLOR **G01** **G04** **G00**



ITEM NO. S-0810L
 PACKING 1 SET/SHRINK, 72 SETS/CTN/0.066CBM 7.2/8.2KGS
 SIZE 80 x 100 x 87 (mm)
 COLOR **G01** **G04** **G00**



ITEM NO. S-1016
 PACKING 1 SET/SHRINK, 72 SETS/CTN/0.063CBM 6.6/7.6KGS
 SIZE 100 x 160 x 45 (mm)
 COLOR **G01** **G04** **G00**



ITEM NO. S-1016L
 PACKING 1 SET/SHRINK, 48 SETS/CTN/0.082CBM 6.5/7.5KGS
 SIZE 100 x 160 x 87 (mm)
 COLOR **G01** **G04** **G00**



ITEM NO. S-0820
 PACKING 1 SET/SHRINK, 72 SETS/CTN/0.063CBM 6.4/7.4KGS
 SIZE 80 x 200 x 45 (mm)
 COLOR **G01** **G04** **G00**



ITEM NO. S-1620
 PACKING 1 SET/SHRINK, 36 SETS/CTN/0.064CBM 5.1/6.1KGS
 SIZE 160 x 200 x 45 (mm)
 COLOR **G01** **G04** **G00**



ITEM NO. S-1620L
 PACKING 1 SET/SHRINK, 24 SETS/CTN/0.083CBM 5.1/6.1KGS
 SIZE 160 x 200 x 87 (mm)
 COLOR **G01** **G04** **G00**

Used in Bathroom

In the bathroom, each family member has his or her own toiletries, which can be organized and sorted using the Blocks Series.



Bathroom



ITEM NO.	B-011
PACKING	1 SET/SHRINK, 24 SETS/CTN/0.073CBM 7.2/8.2KGS
SIZE	160 x 300 x 50 (mm)
INCLUDE	S-0810 \ S-1016 \ S-1620
COLOR	G01 G04 G00



ITEM NO.	B-012
PACKING	1 SET/SHRINK, 24 SETS/CTN/0.092CBM 10.8/11.8KGS
SIZE	160 x 200 x 96 (mm)
INCLUDE	S-0810L \ S-1016L \ S-1620L
COLOR	G01 G04 G00



ITEM NO.	B-013
PACKING	1 SET/SHRINK, 24 SETS/CTN/0.095CBM 14/15KGS
SIZE	160 x 200 x 104 (mm)
INCLUDE	S-0810 \ S-0810L \ S-1016 \ S-1016L \ S-1620L
COLOR	G01 G04 G00

Used in Kitchen

In the kitchen, not only the tableware in drawers needs to be stored, but also many condiments and tools.



Kitchen



ITEM NO.	B-014
PACKING	1 SET/SHRINK, 24 SETS/CTN/0.123CBM 12.7/13.7KGS
SIZE	200 x 240 x 87 (mm)
INCLUDE	S-0810 x 2 \ S-0810L \ S-1016 \ S-1620L
COLOR	G01 G04 G00



ITEM NO.	B-015
PACKING	1 SET/SHRINK, 24 SETS/CTN/0.127CBM 13/14.5KGS
SIZE	200 x 240 x 87 (mm)
INCLUDE	S-0810 \ S-0810L \ S-0820 x 2 \ S-1620L
COLOR	G01 G04 G00



ITEM NO.	B-016
PACKING	1 SET/SHRINK, 24 SETS/CTN/0.123CBM 12/13.8KGS
SIZE	200 x 240 x 87 (mm)
INCLUDE	S-0810 x 2 \ S-1016 \ S-0820 x 2 \ S-1620
COLOR	G01 G04 G00

Wall Storage

Increase storage space on the wall

- Bubble Series -
- Pocket Series -

Bubble Series

Using walls to save flat space has always been a good way to organize your home, but in addition to function, what is more important is beautiful shape and series, which can add color to an elegant interior.



Includes

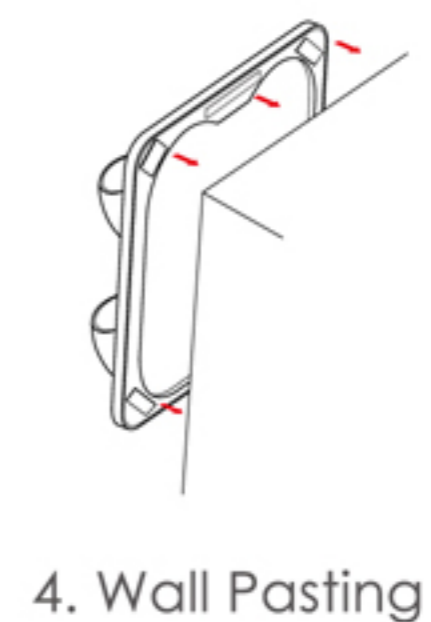
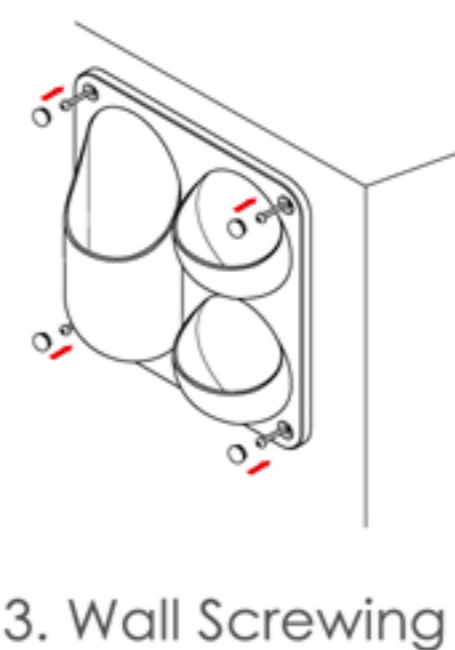
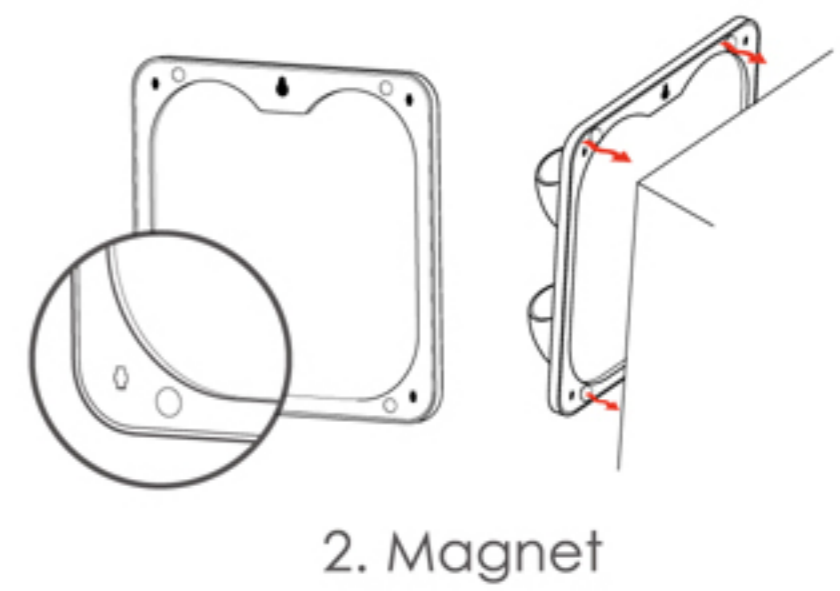
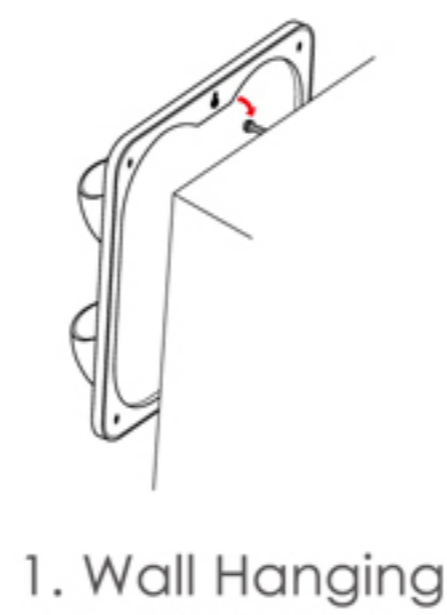
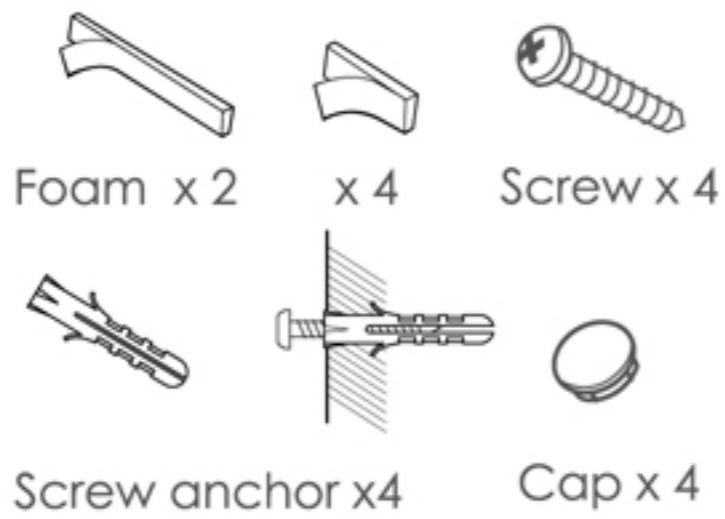

Video



ITEM NO. S-881
 PACKING 1 SET/WINDOW BOX, 36 SETS/CTN/0.115CBM 13/14.5KGS
 SIZE 210 x 210 x 53 (mm)
 COLOR 01 04 18 10 00



ITEM NO. S-882
 PACKING 1 SET/WINDOW BOX, 36 SETS/CTN/0.115CBM 12/13.5KGS
 SIZE 210 x 210 x 53 (mm)
 COLOR 01 04 18 10 00



ITEM NO. S-883
 PACKING 1 SET/WINDOW BOX, 36 SETS/CTN/0.115CBM 11.5/13KGS
 SIZE 210 x 210 x 53 (mm)
 COLOR 01 04 18 10 00



ITEM NO. S-884
 PACKING 1 SET/WINDOW BOX, 36 SETS/CTN/0.115CBM 11.5/13KGS
 SIZE 210 x 210 x 53 (mm)
 COLOR 01 04 18 10 00



ITEM NO. S-885
 PACKING 1 SET/WINDOW BOX, 36 SETS/CTN/0.115CBM 11.2/12.7KGS
 SIZE 210 x 210 x 53 (mm)
 COLOR 01 04 18 10 00



ITEM NO. S-887
 PACKING 1 SET/WINDOW BOX, 36 SETS/CTN/0.115CBM 11.5/13KGS
 SIZE 210 x 210 x 50 (mm)
 COLOR 01 04 18 10 00



Pocket Series

The compact and flexible Pocket Series is suitable for a variety of places, just like adding pockets to the space, allowing you to keep frequently used items at your fingertips.



Locker



Video



Kitchen



Bathroom



ITEM NO.	S-102 (With Nano Tape : N-102)
PACKING	1 SET/SHRINK, 180 SETS/CTN/0.067CBM 10/11KGS
SIZE	125 x 88 x 22 (mm)
COLOR	<input type="checkbox"/> 01 <input type="checkbox"/> 18 <input type="checkbox"/> 15 <input type="checkbox"/> 31 <input type="checkbox"/> 00



ITEM NO.	S-105 (With Nano Tape : N-105)
PACKING	1 SET/SHRINK, 96 SETS/CTN/0.085CBM 9/10KGS
SIZE	88 x 169 x 45 (mm)
COLOR	<input type="checkbox"/> 01 <input type="checkbox"/> 18 <input type="checkbox"/> 15 <input type="checkbox"/> 31 <input type="checkbox"/> 00



ITEM NO.	S-106 (With Nano Tape : N-106)
PACKING	1 SET/SHRINK, 144 SETS/CTN/0.090CBM 10.5/11.5KGS
SIZE	125 x 88 x 45 (mm)
COLOR	<input type="checkbox"/> 01 <input type="checkbox"/> 18 <input type="checkbox"/> 15 <input type="checkbox"/> 31 <input type="checkbox"/> 00



ITEM NO.	S-107 (With Nano Tape : N-107)
PACKING	1 SET/SHRINK, 48 SETS/CTN/0.076CBM 7.7/8.7KGS
SIZE	180 x 118 x 60 (mm)
COLOR	<input type="checkbox"/> 01 <input type="checkbox"/> 18 <input type="checkbox"/> 15 <input type="checkbox"/> 31 <input type="checkbox"/> 00



ITEM NO.	S-108
PACKING	1 PCS/POLY BAG, 72 SETS/CTN/0.082CBM 8.3/9.8KGS
SIZE	220 x 92 x 230 (mm)
COLOR	T01 T18 T15 T31



ITEM NO.	S-1083
PACKING	3 PCS/PAPER BAND, 24 SETS/CTN/0.099CBM 7.7/9.2KGS
SIZE	220 x 97 x 258 (mm)
COLOR	T01 T18 T15 T31



① Hanger : Rotating 360

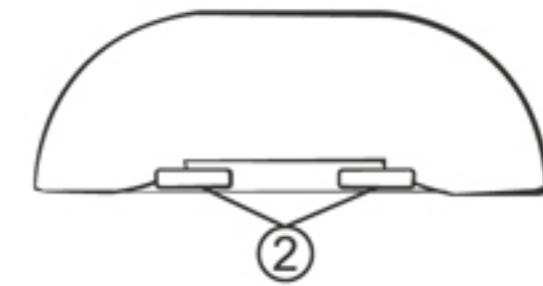

② Holes : Draining & linking

Hanging Pocket

Unlike other Pocket Series, it does not use adhesives or magnets, but hooks.

It is suitable for use in places with cross bars, such as bedrooms, kitchens, and bathrooms.



Video



Bathroom



Closet

Vanity Storage

- Makeup Organizer -
- Skin Care Organizer -
- Drawer Organizer -
- Wall Organizer -
- Jewelry Storage -
- Tool Storage -

Create your own dream space



Vanity Desk

According to research, students start wearing makeup as early as elementary school, which shows that having their own makeup space is every female's dream. However, as the number of cosmetics increases, storage becomes relatively important.



Makeup Organizer

Today's cosmetics storage is arranged from front to back, and when accessing items in the rear, they are always blocked by items in the front.

Therefore, we redesigned the Makeup Organizer, changed the arrangement from left to right, and gave it an angle to make it easier to find and take it!



Video



Primer and Cream



Makeup Palette



Tool Storage



Lipstick Storage



ITEM NO.	S-330
PACKING	1 SET/COLOR BOX, 18 SETS/CTN/0.085/CBM 8.6/10.1 KGS
SIZE	241 x 145 x 102 (mm)
COLOR	T01 01 18 31 00



ITEM NO.	S-332
PACKING	1 SET/COLOR BOX, 12 SETS/CTN/0.072/CBM 8.2/9.7 KGS
SIZE	240 x 145 x 129 (mm)
COLOR	T01 01 18 31 00



Skin Care & Drawer Organizer

The reason why Vanity table is not easy to organize is because besides of cosmetics, there are too many skin care bottles and jars, so we recommend you to use Join Box and Blocks Series to organize the drawers and cabinets of Vanity Desk !



Cream Container

S-710 / Page : 04



Pump Bottle

S-720 / Page : 04



Cosmetic

Blocks / Page : 12



Quick Access & Jewelry Storage

In addition to classification and neat arrangement, storage rules are more important for easy access. As long as you put commonly used items in a convenient area, you can quickly find the items you need during the makeup process.



Makeup Accessories

S-107 / Page : 18

Jewelry Storage

S-113 / Page : 31

Rotary Tool Organizer

S-899 / Page : 33

Living Room Storage

Improve your quality of life

- Remote Control Holder -
- Entrance Storage -



Remote Control Holder

Remote controls, nail clippers, cotton swabs, etc. are common items on the side table in the living room.



ITEM NO.	S-895
PACKING	1 SET/COLOR BOX, 18 SETS/CTN/0.110CBM 13.5/14.5 KGS
SIZE	301 x 160 x 92 (mm)
COLOR	01 04 31



Rotation Solution

The rotation function can help you access the items behind, save space, and give the living room an elegant texture.



ITEM NO.	S-350E
PACKING	1 SET/COLOR BOX, 24 SETS/CTN/0.110CBM 11/12.5 KGS
SIZE	Ø 161 x 118 (mm)
COLOR	00 G01 S08 G04 G30

Simple Solution

For minimalists, we recommend using Blocks Series to organize living room storage in a low-key way without losing beauty and functionality.



ITEM NO.	S-0810L
PACKING	1 SET/SHRINK, 72 SETS/CTN/0.066CBM 7.2/8.2KGS
SIZE	80 x 100 x 87 (mm)
COLOR	G01 G04 G00

Entrance Storage

First thing you do when you get home

- Common Items Storage -
- Family Members Storage -
- Shoe Cabinet Storage -



Smart Tray

Frequently used items should be placed in a conspicuous place so that they will not be lost !



ITEM NO.	S-111
PACKING	1 SET/COLOR BOX, 24 SETS/CTN/0.109CBM 10.8/11.8KGS
SIZE	214 x 214 x 72 (mm)
COLOR	<input type="checkbox"/> 01 <input type="checkbox"/> 18 <input type="checkbox"/> 10 <input type="checkbox"/> 00

Combo Box

At the entrance, the Combo Box is suitable for storing family members' keys, car keys, coins, etc.



ITEM NO.	S-3384
PACKING	1 SET/SHRINK, 18 SETS/CTN/0.064CBM 8.9/10.4KGS
SIZE	200 x 95 x 143 (mm)
COLOR	01 18 31 00

Folding Box

The Folding Box has two main usages in the entrance. The first is to store items in shoe cabinets, and the second is to store pet supplies.



ITEM NO.	S-310
PACKING	1 SET/SHRINK, 36SETS/CTN/0.071/CBM 12/13 KGS
SIZE	303 x 163 x 104.2 (mm)
COLOR	T01 01 18 31 00

Smart Organizer

Smart way with smart device

- Target Series -
- Smart Series -



Target Series

With the advanced technology, we have redefined the traditional letter tray and combined it with the current technology of laptops and tablets to create a new generation of Letter Tray designs.

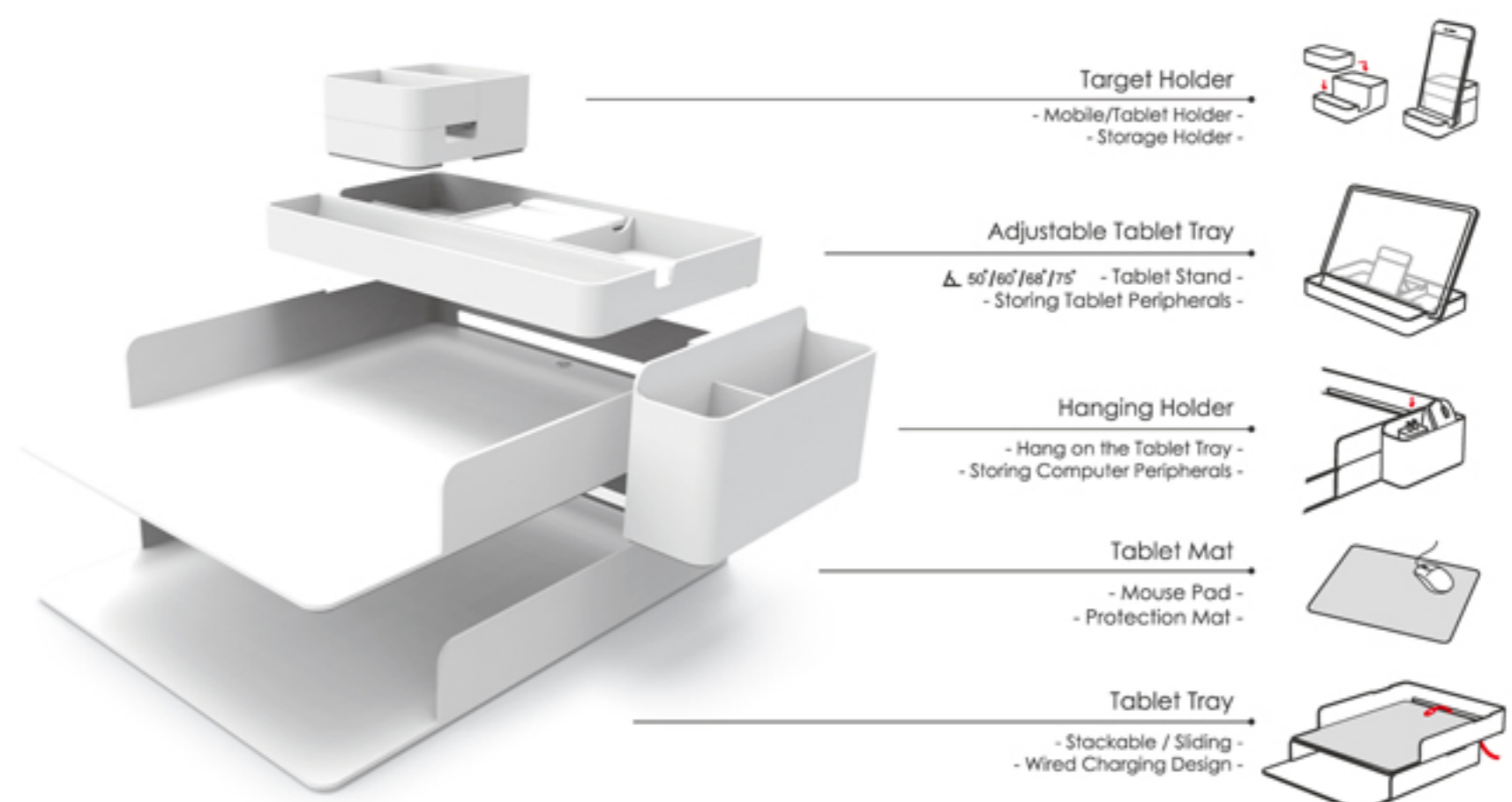

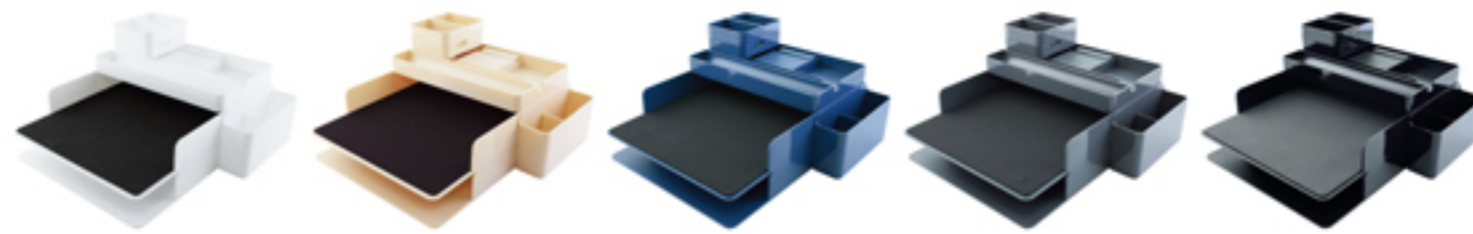
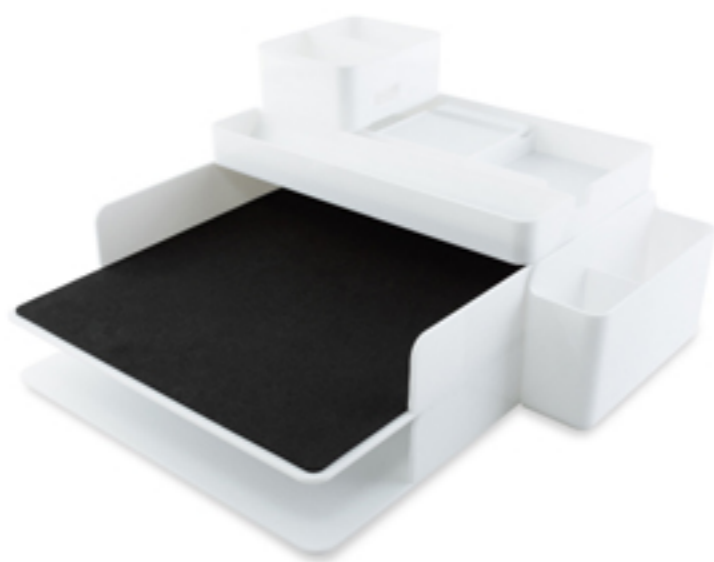

ITEM NO. TS-101
 PACKING 1 SET/COLOR BOX, 12 SETS/CTN/0.08 CBM 13.9/14.9 KGS
 SIZE 285 x 310 x 153 (mm)
 COLOR 01 18 10 31 00



ITEM NO. TS-001 (2PCS/SET)
 PACKING 1 SET/SHRINK, 12 SETS/CTN/0.08 CBM 7.5/8.5 KGS
 SIZE 285 x 310 x 153 (mm)
 COLOR 01 18 10 31 00



ITEM NO. TS-002
 PACKING 1 SET/SHRINK, 45 SETS/CTN/0.052 CBM 9/10 KGS
 SIZE 240 x 145 x 27 (mm)
 COLOR 01 18 10 31 00



ITEM NO. TS-003
 PACKING 1 SET/SHRINK, 72 SETS/CTN/0.032 CBM 4.5/5.5 KGS
 SIZE 80 x 100 x 45 (mm)
 COLOR 01 18 10 31 00



ITEM NO. TS-004
 PACKING 1 SET/SHRINK, 48 SETS/CTN/0.034 CBM 3.6/4.6 KGS
 SIZE 145 X 45 X 85 (mm)
 COLOR 01 18 10 31 00



Video

Vertical Laptop Stand

Storage & colling in one



When using a laptop, one of the biggest challenges is limited desk space, making it difficult to store and manage overheating issues. To address this problem, we have designed a new Vertical Laptop Stand.

The TS-005 stands out from other laptop stands on the market because typical laptop stands can not simultaneously provide both storage and cooling functions. However, the TS-005 achieves this.



✓ Colling Function
✗ Storage Function



✗ Colling Function
✓ Storage Function



The TS-005 Vertical Laptop Stand can hold a laptop / tablet / keyboard and other accessories while also serving as a cooling stand, making it a groundbreaking product.



Laptops / tablets / notebooks / keyboards



Expandable design fits various sizes.



More storage space



Cooling function



ITEM NO.	TS-005
PACKING	1 SET/COLOR BOX, 36 SETS/CTN/0.08 CBM 10.5/11.5 KGS
SIZE	160 x 152 x 68 (mm)
COLOR	01 18 00

Smart Tray

We combine the storage tray with the Tablet Stand, whether it is used for studying in the room or watching cooking classes in the kitchen.



ITEM NO.	S-111
PACKING	1 SET/COLOR BOX, 24 SETS/CTN/0.109CBM 10.8/11.8KGS
SIZE	214 x 214 x 72 (mm)
COLOR	01 18 10 00

Smart Holder

It has been disturbed on the issue of too long charging cables of mobile. So we add the design of the cables storing function at the bottom of the organizer to be able to do charging on the desktop.

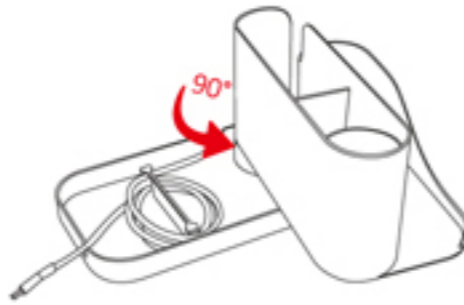

Cable Winding



ITEM NO.	S-112
PACKING	1 SET/COLOR BOX, 24 SETS/CTN/0.071CBM 12/13.5KGS
SIZE	180 x 98 x 107 (mm)
COLOR	01 18 10 00

Smart Box

The wires of the technology products which are not only used on mobiles, but also others, like USB-A, USB-C, MICRO USB...etc. You could use our Smart Box to store and sort them out into categories inside this elegant box.



3 Layers Design



ITEM NO.	S-113
PACKING	1 SET/SHRINK, 24 SETS/CTN/0.058CBM 6.4/7.4KGS
SIZE	200 x 121 x 77.5 (mm)
COLOR	01 18 10 00

Smart Bookend

We combine stationery storage with bookends to solve the need for computers, books, and stationery items to be placed on small desktops at the same time.

Includes

Screw x 4

The baseboard x 2

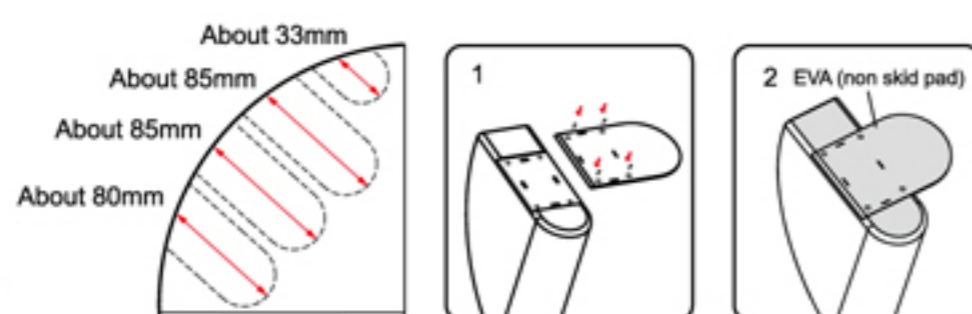

ITEM NO.	S-833
PACKING	1 SET/COLOR BOX, 24 SETS/CTN/0.120CBM 14.3/15.6KGS
SIZE	120 x 160 x 180 (mm)
COLOR	01 18 10 00

Desk Organizer

- Twotone Series -
- S Series -

Improve the quality of your work

Twotone Series

"Twotone" means a combination of two colors, and it is also our classic series! The neat lines and elegant shape can make your working environment more upscale.



ITEM NO.	S-899
PACKING	1 SET/COLOR BOX, 24 SETS/CTN/0.100CBM 12.5/13.5KGS
SIZE	Ø 161 x 92 (mm)
COLOR	01 04 31



ITEM NO.	S-897
PACKING	1 SET/COLOR BOX, 24 SETS/CTN/0.090CBM 12.6/13.8KGS
SIZE	Ø 150 x 89 (mm)
COLOR	01 04 31



ITEM NO.	S-895A
PACKING	1 SET/COLOR BOX, 18 SETS/CTN/0.110CBM 16.5/17.5KGS
SIZE	301 x 160 x 92 (mm)
COLOR	01 04 31



Desk Organizer

Desk Organizer is like a coach on the court, planning and assigning the function and location of each stationery.



Video



ITEM NO.	S-118
PACKING	1 SET/COLOR BOX, 24 SETS/CTN/0.080CBM 13.8/14.8KGS
SIZE	130 x 130 x 103 (mm)
COLOR	01 04 31



ITEM NO.	S-898
PACKING	1 SET/COLOR BOX, 24 SETS/CTN/0.100CBM 14/15.5KGS
SIZE	128 x 140 x 128 (mm)
COLOR	01 04 31



ITEM NO.	S-886
PACKING	1 SET/COLOR BOX, 36 SETS/CTN/0.120CBM 18/19KGS
SIZE	110 x 110 x 93 (mm)
COLOR	01 04 31



ITEM NO.	S-061
PACKING	1 SET/COLOR BOX, 36 SETS/CTN/0.110CBM 17/18.5KGS
SIZE	Ø 109 x 140 (mm)
COLOR	18 15 10 00



ITEM NO.	S-828
PACKING	1 SET/COLOR BOX, 36 SETS/CTN/0.120CBM 16/17.5KGS
SIZE	Ø 128 x 108 (mm)
COLOR	18 15 10 00



ITEM NO.	S-351
PACKING	1 SET/COLOR BOX, 36 SETS/CTN/0.055CBM 13/14KGS
SIZE	80 x 81 x 81 (mm)
COLOR	18 15 10

Sierra Blue

Sierra Blue is a fresh and simple color, lively but elegant like a little princess. It is suitable for female groups in elementary and middle schools.





ITEM NO.	S-084
PACKING	1 SET/COLOR BOX, 36 SETS/CTN/0.110CBM 18/19.5KGS
SIZE	Ø 120 x 140 (mm)
COLOR	18 15 10 00



ITEM NO.	S-056
PACKING	1 SET/COLOR BOX, 24 SETS/CTN/0.110CBM 15/16.5KGS
SIZE	Ø 166 x 120 (mm)
COLOR	01 10 00

Prussian Blue

It is a calm, low-key and mysterious color, just like the depths of the blue sea, tranquil but rich in life.

This color is suitable for men, whether they are college students or successful people.



S Series

Because of persistence,
classics are achieved.



ITEM NO.	S-358
PACKING	1 SET/COLOR BOX, 36 SETS/CTN/0.070CBM 11/12KGS
SIZE	68 x 132 x 110 (mm)
COLOR	G00 G01 S08 G04



ITEM NO.	S-920
PACKING	1 SET/COLOR BOX, 36 SETS/CTN/0.055CBM 7.3/8.3KGS
SIZE	100 x 160 x 128 (mm)
COLOR	G00 G01 G04



ITEM NO.	A-510
PACKING	1 SET/CANDY BAG , 48 SETS/CTN/0.103CBM 10.5/11.8KGS
SIZE	Ø 100 x 111 (mm)
COLOR	01 24 28 25



ITEM NO.	S-918
PACKING	1 SET/COLOR BOX, 36 SETS/CTN/0.124CBM 17.5/18.5KGS
SIZE	100 x 160 x 128 (mm)
COLOR	G00 G01 G04



ITEM NO.	S-1810
PACKING	1 SET/COLOR BOX, 48 SETS/CTN/0.067CBM 10.7/11.7KGS
SIZE	80 x 100 x 87 (mm)
COLOR	G00 G01 G04



S Series

The transparent texture shines like a gem, a symbol of noble status.



ITEM NO.	S-350
PACKING	1 SET/COLOR BOX, 24 SETS/CTN/0.110CBM 15/16.5KGS
SIZE	Ø 161 x 118 (mm)
COLOR	00 G01 S08 G04 G30



ITEM NO.	S-356
PACKING	1 SET/COLOR BOX, 36 SETS/CTN/0.100CBM 17.5/18.5KGS
SIZE	150 x 135 x 90 (mm)
COLOR	00 G01 S08 G04 G30



ITEM NO.	S-908
PACKING	1 SET/COLOR BOX, 24 SETS/CTN/0.094CBM 12/13.5KGS
SIZE	Ø 161 x 125 (mm)
COLOR	00 G01 S08 G04 G30



ITEM NO. S-929
 PACKING 1 SET/COLOR BOX, 36 SETS/CTN/0.117CBM 19.7/21KGS
 SIZE 127 x 127 x 105 (mm)
 COLOR 00 G01 S08 G04 G30



ITEM NO. S-357
 PACKING 1 SET/COLOR BOX, 24 SETS/CTN/0.080CBM 12.5/13.5KGS
 SIZE 128 x 128 x 130 (mm)
 COLOR 00 G01 S08 G04 G30



ITEM NO. S-088
 PACKING 1 SET/COLOR BOX, 24 SETS/CTN/0.073CBM 12/13KGS
 SIZE 160 x 136 x 83 (mm)
 COLOR 00 G01 S08 G04 G30



! Front side - photo frame.
 ! Back side - magnet.

ITEM NO. S-770
 PACKING 1 SET/COLOR BOX, 48 SETS/CTN/0.097CBM 20/21.5KGS
 SIZE 51 x 154 x 95 (mm)
 COLOR 00 G01 S08 G04 G30

Office Accessories

- Memo Holder -
- Desk Accessories -
- Magazine File -
- Desk Pad -

Not only useful, but also decorative

Memo Holder

Through our dispenser, sticky notes could be taken like using tissues in extracting directly to get them easily under urgent needs, avoiding time waste.



Includes

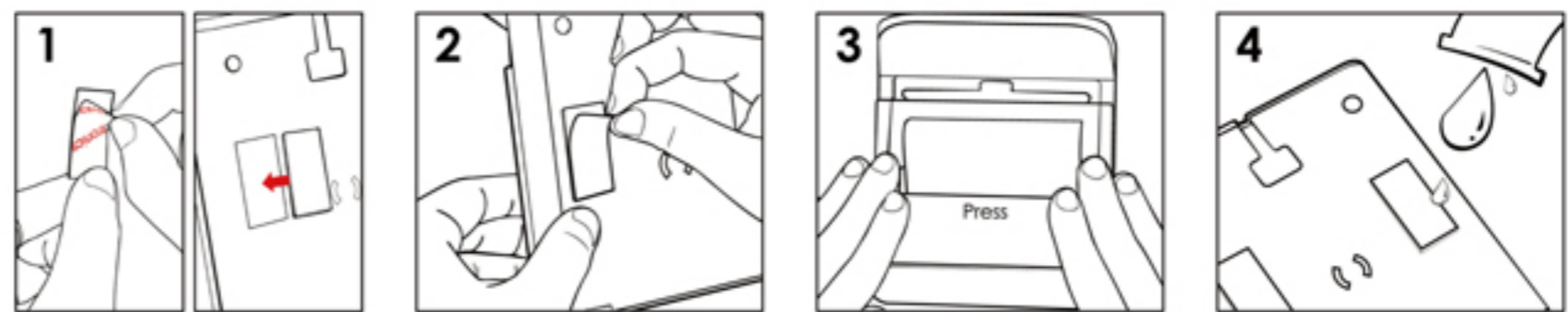

ITEM NO.	S-335
PACKING	1 SET/SHRINK, 72 SETS/CTN/0.040CBM 9/10KGS
SIZE	104 x 115 x 60 (mm)
COLOR	18 15 10



Includes: Pop-Up Memo x 1, PU Tape x 2

ITEM NO.	S-333
PACKING	1 SET/WINDOW BOX, 144 SETS/CTN/0.072CBM 17.3/18.3KGS
SIZE	130 x 88 x 31 (mm)
COLOR	18 15 10

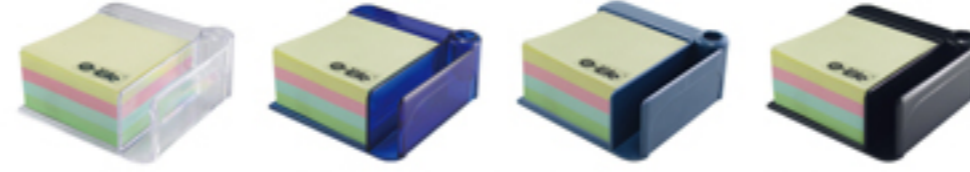

Includes Rainbow Cube 3" x 3" x 400 Sheets, Sticky Note.

ITEM NO.	S-308
PACKING	1 SET/SHRINK, 72 SETS/CTN/0.042CBM 16.5/17KGS
SIZE	104 x 104 x 45 (mm)
COLOR	T01 G30 10 00

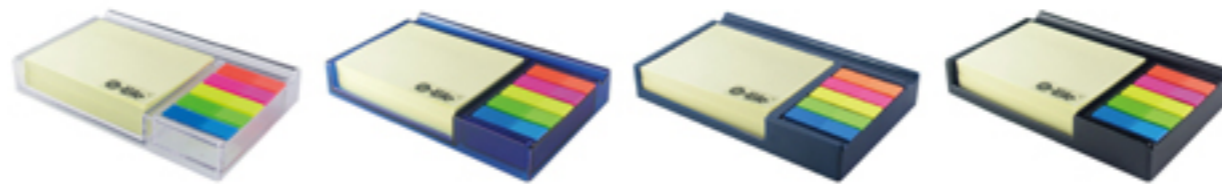

ITEM NO.	S-309
PACKING	1 SET/SHRINK, 48 SET/CTN/0.028CBM 8.8/9.8KGS
SIZE	165 x 104 x 25 (mm)
COLOR	T01 G30 10 00

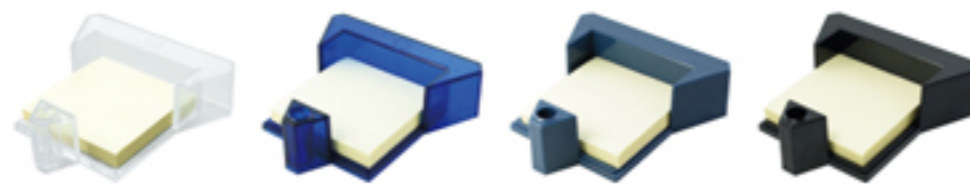
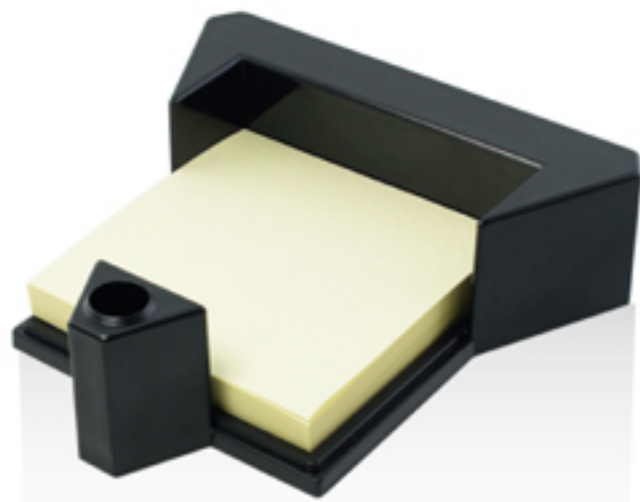

Includes 3" x 3" x 100 Sheets, Sticky Notes.

ITEM NO.	K-301
PACKING	1 SET/SHRINK, 120 SETS/CTN/0.103CBM 11/12 KGS
SIZE	120 x 120 x 37 (mm)
COLOR	T01 G30 10 00



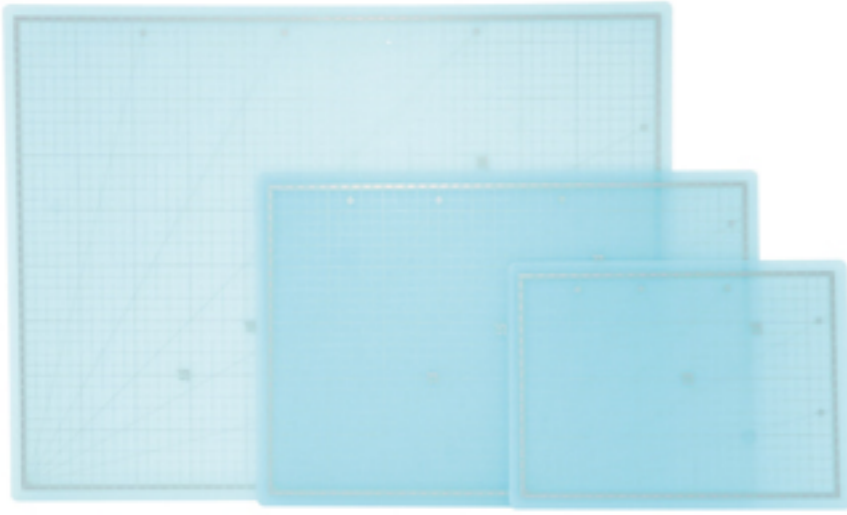

Cutting Mats

ITEM NO.	A2 / A3 / A4
PACKING	A2 : 1 PC/OPP BAG, 24 PCS/CTN/0.037 CBM 15/16 KGS
PACKING	A3 : 1 PC/OPP BAG, 36 PCS/CTN/0.026 CBM 11.5/12.5 KGS
PACKING	A4 : 1 PC/OPP BAG, 72 PCS/CTN/0.028 CBM 11.5/12.5 KGS
SIZE	600 x 450 x 2 (mm) / 450 x 300 x 2 (mm) / 300 x 220 x 2 (mm)
COLOR	T01 T03 T30

- ECO material, non-toxic
- Non slip surface
- Self-healing and smooth writing after cutting



MATERIAL DESCRIPTION

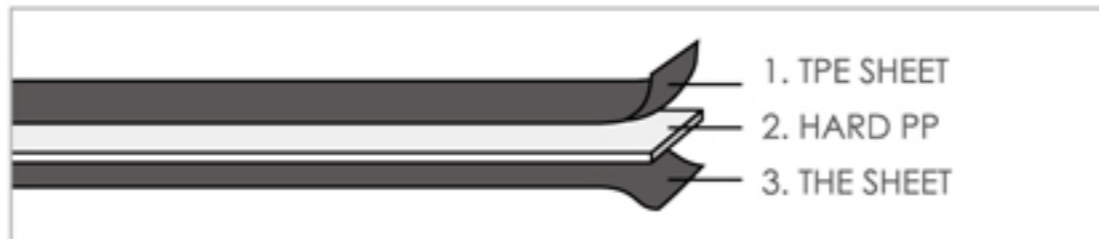

Translucent color could be seen through.

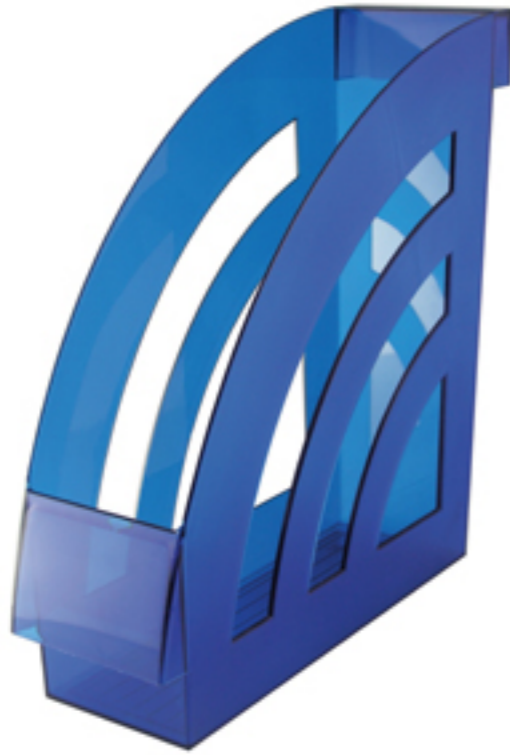

ITEM NO.	1038
PACKING	1 SET/POLY BAG, 24 SETS/CTN/0.138CBM 10.7/11.7KGS
SIZE	87 x 298 x 300 (mm)
COLOR	00 S03 S08 S04 G30



ITEM NO.	1030-CL028C
DESC.	28mm PAPER CLIP (COLOR) / (80PCS)
PACKING	12 HOLDERS/PVC BOX, 24 BOXES/CTN/0.074CBM
N.W./G.W.	19.4/20.9KGS
COLOR	S04 S03 S08 S30



ITEM NO.	1030-CL028B
DESC.	28mm PAPER CLIP (COLOR) / (80PCS)
PACKING	12 HOLDERS/PVC BOX, 24 BOXES/CTN/0.074CBM
N.W./G.W.	19.4/20.9KGS
COLOR	S04 S03 S08 S30

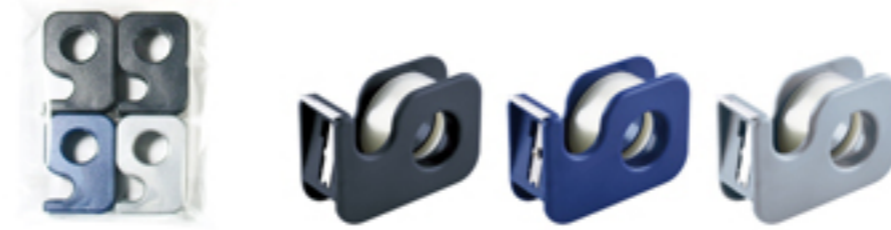

ITEM NO. K-001A
 PACKING 4 PCS/HEADER BAG, 216 BAGS/CTN/0.090CBM 18.5/20KGS
 SIZE 67 x 24 x 47 (mm)
 COLOR 00 M33 M31



ITEM NO. K-200A
 PACKING 4 PCS/HEADER BAG, 216 BAGS/CTN/0.081CBM 22/23.5KGS
 SIZE 68 x 27 x 46 (mm)
 COLOR S04 S03 S08 S30



ITEM NO. 1016
 PACKING 1 PC/HEADER BAG, 240 PCS/INNER, 960 PCS/CTN/0.043CBM 14/15.5KGS
 SIZE 219 x 30 x 3 (mm)
 COLOR 00 T01 G00 G30



FUNCTION :



ITEM NO. 1009 (3 IN 1 RULER)
 PACKING 1 PC/HEADER BAG, 240 PCS/INNER, 960 PCS/CTN/0.039CBM 14/15KGS
 SIZE 165 x 47 x 2 (mm)
 COLOR T01 S08 S04 G30



INTERLINK®

因特林企業有限公司
INTERLINK ENTERPRISE CO., LTD.

新北市汐止區大同路二段163號10樓 遠東科技中心B棟
10F., No.163, Sec.2, Datong Rd., Xizhi Dist., New Taipei City 221424 Taiwan
Tel: 886-2-86926922 Fax: 886-2-86926921
E-mail: Lucychan@interlink-ltd.com
www.interlink-ltd.com

2410



Website & E-catalogue